

Characteristics



E205



E405

General characteristics

No. of poles	2 Form C (2PDT)	4 Form C (4PDT)
Volume	3.3 cm ³ [.2 in ³]	6.9 cm ³ [.42 in ³]
Mass	15.4 grams [.034 lb. Max]	26.4 grams [.058 lb. Max]

Switching characteristics

Operate time @ 25° C	5 ms max.	6 ms max.
Release time @ 25° C	5 ms max.	6 ms max.
Bounce time	1 ms max.	1 ms max.
Mechanical life	400,000 cycles	

Contact rating	Type of load (High level)	Cycles x 10 ³	28 Vdc	115 Vac	115/200 Vac
				400 Hz 1 phase	400 Hz 3 phase
	Resistive	100	5 amps	5 amps	5 amps
	Inductive	20	3 amps	5 amps	5 amps
	Motor	100	2 amps	3 amps	3 amps
	Lamp	100	1 amps	n/a	n/a
	Overload current	n/a	20 amps	30 amps	30 amps
	Rupture current	n/a	25 amps	40 amps	40 amps

Environmental characteristics

Temperature Range	-70°C to +125°C
Vibration (Sinusoidal) - E405 mounting style 3	30 g 70-3000 Hz 20 g 57-3000 Hz
Shock, any axis - E405 mounting style 3	200 g 6 ms 100 g 6 ms
Seal	Hermetic (1 x 10 ⁻⁸ atm cm ³ /s)

Electrical characteristics

Contact voltage drop (@ Rated resistive load) - Initial - After guaranteed life	150 mV Max. 175 mV Max.						
Dielectric strength @ sea level - Initial @ 60 Hz - After life test @ 60 Hz	<table border="1"> <thead> <tr> <th>Coil to Case</th> <th>All other points</th> </tr> </thead> <tbody> <tr> <td>1000 Vrms</td> <td>1000 Vrms</td> </tr> <tr> <td>750 Vrms</td> <td>750 Vrms</td> </tr> </tbody> </table>	Coil to Case	All other points	1000 Vrms	1000 Vrms	750 Vrms	750 Vrms
Coil to Case	All other points						
1000 Vrms	1000 Vrms						
750 Vrms	750 Vrms						
Insulation Resistance - Initial - After life tests	100 Megohms min. @ 500 Vdc 50 Megohms min. @ 500 Vdc						
Reference Military Specifications	MIL-PRF-83536						

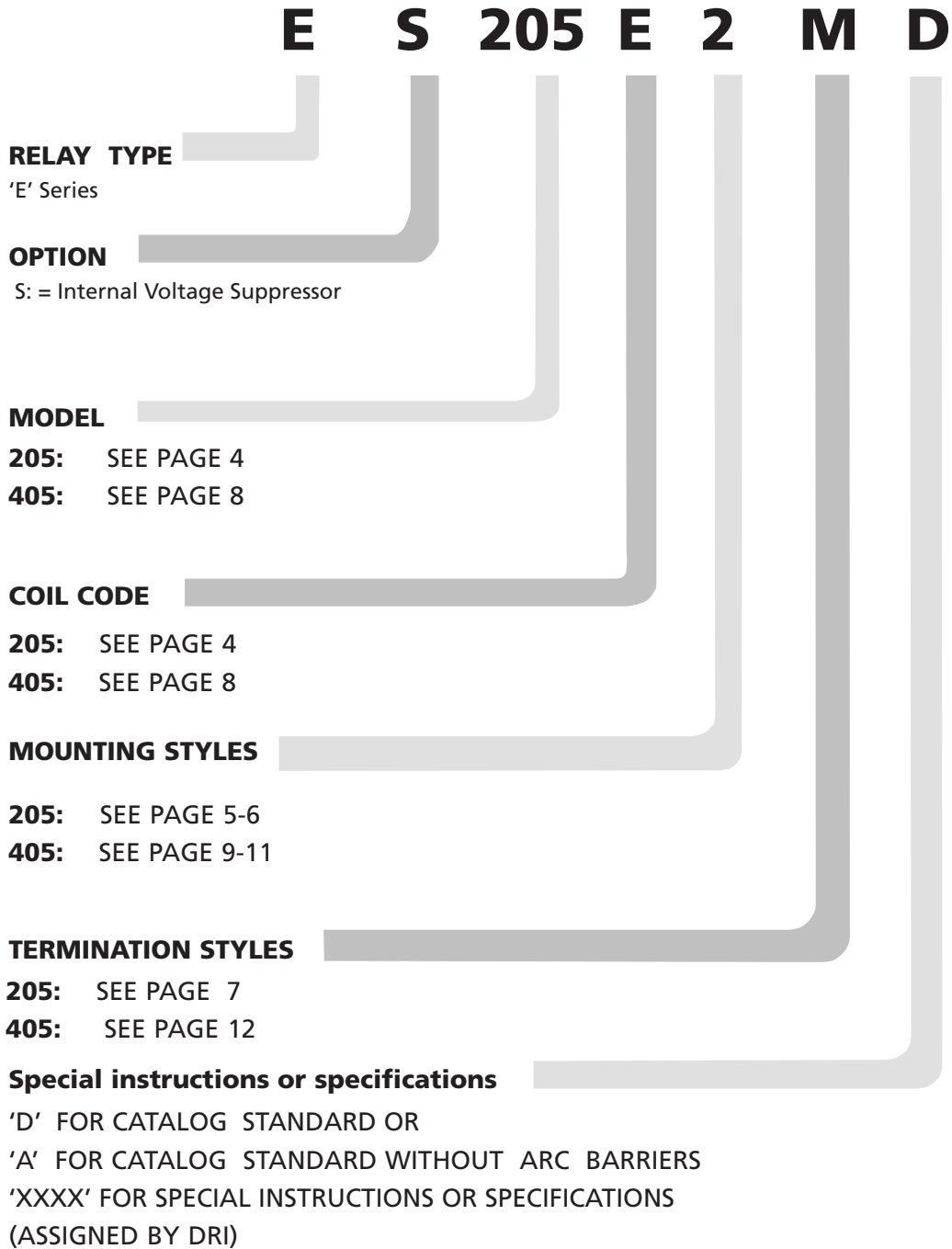

Coil Characteristics

COIL CODE	DC							
	A	B	D	E	F	G	H	J
Nominal coil voltage	6	12	26,5	28	36	48	74	110
Maximum pick-up voltage at 25°C	3,3	6,5	13,5	13,5	16,7	24	34,7	50
Maximum pick-up voltage at 125°C	4,5	9	18	18	23	36	48	70
Maximum hold voltage at 125°C	2,3	4,5	7	7	10	12	21	30
Minimum drop-out voltage at -70°C	0,25	0,5	1,2	1,5	2	2,4	4	5,5
Coil resistance (ohms ± 10% at 25° C)	23	90	440	500	825	1400	3500	5000
Max coil transient suppression (where applicable) VDC	-42	-42	-42	-42	-100	-100	-100	-154

OTHER VOLTAGES AVAILABLE FROM FACTORY ON REQUEST

Circuit Diagram

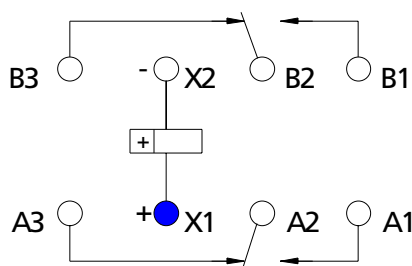

E205

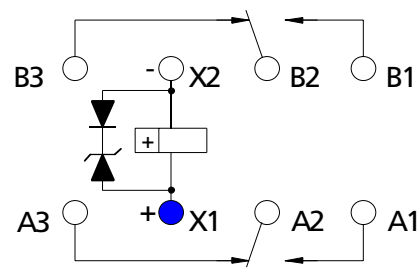

ES205

OPTIONAL INTERNAL
VOLTAGE SUPPRESSOR

■ Mounting styles

DIMENSIONS ARE IN MM (IN.)
UNLESS OTHERWISE SPECIFIED, TOLERANCE IS $\pm 0,25$ [.010]

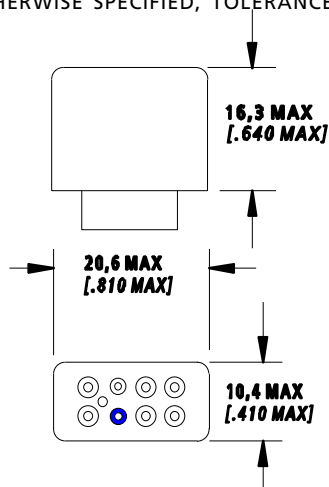

STYLE 1
NO MOUNT

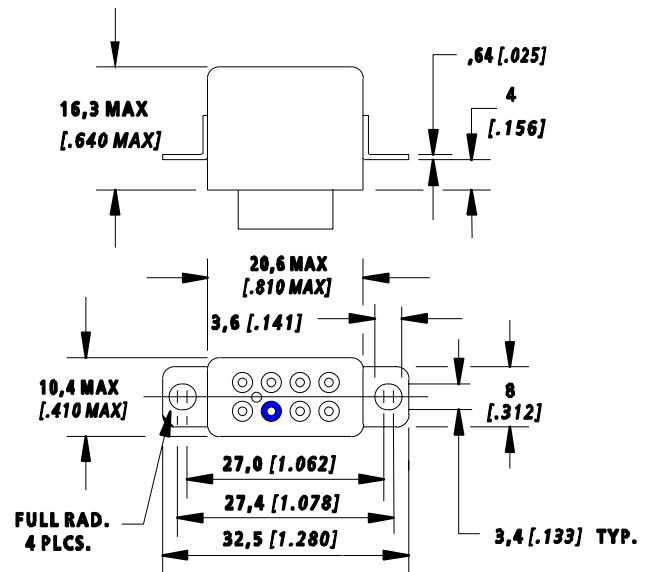

STYLE 2
RAISED VERTICAL FLANGE MOUNT

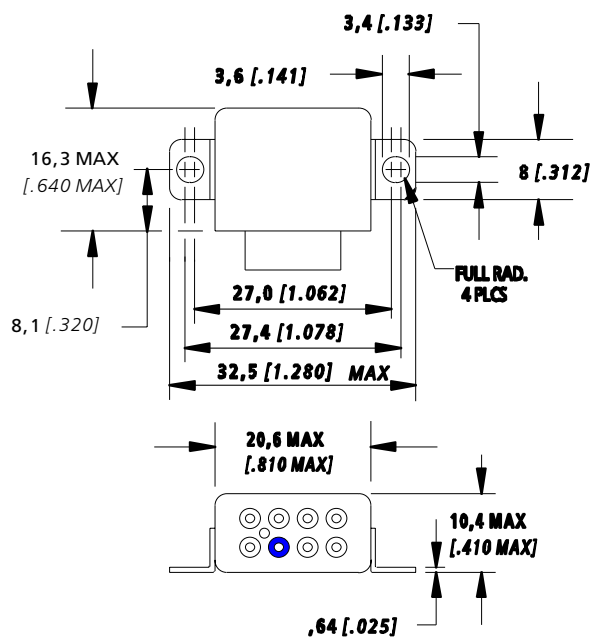

STYLE 3
HORIZONTAL FLANGE MOUNT

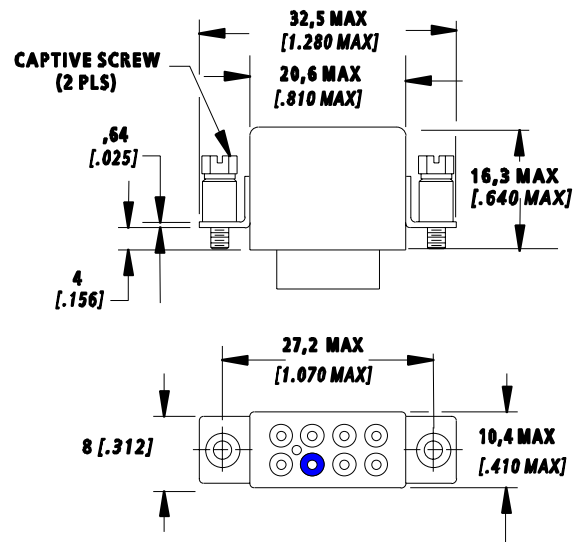

STYLE 8: M3 CAPTIVE SCREWS
STYLE C: #4-40 UNC CAPTIVE SCREWS
RAISED VERTICAL FLANGE MOUNT
WITH CAPTIVE HARDWARE

■ Mounting styles (cont'd.)

DIMENSIONS ARE IN MM (IN.)
UNLESS OTHERWISE SPECIFIED, TOLERANCE IS $\pm 0,25$ [.010]

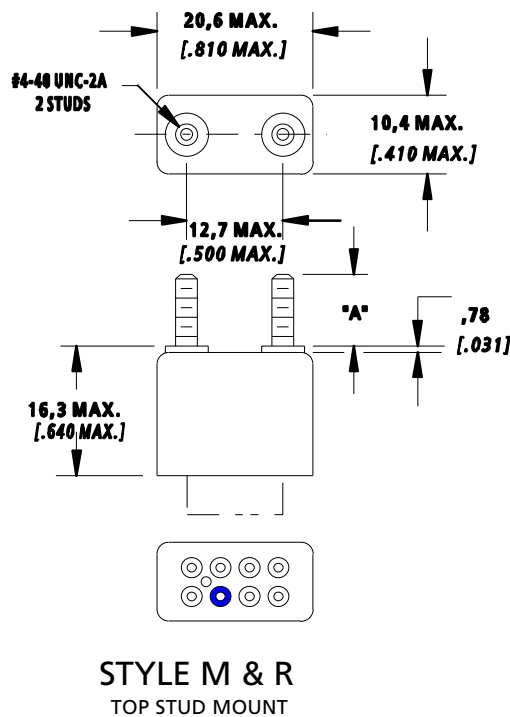
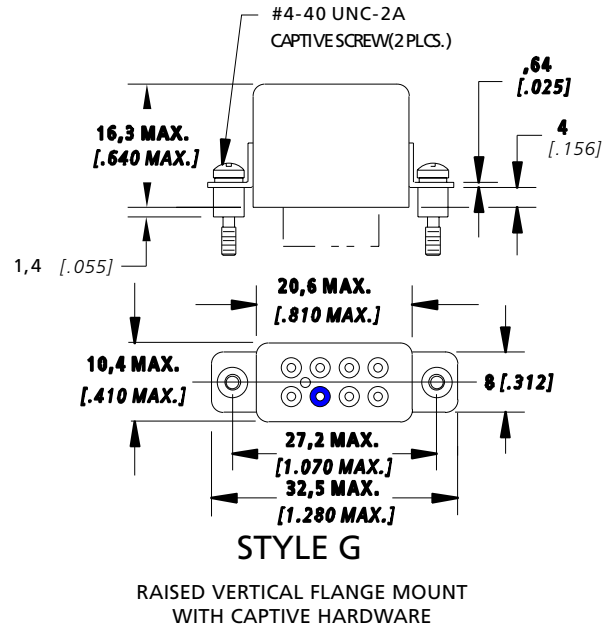

Termination styles

DIMENSIONS ARE IN MM (IN.)
UNLESS OTHERWISE SPECIFIED, TOLERANCE IS $\pm 0,25$ [.010]

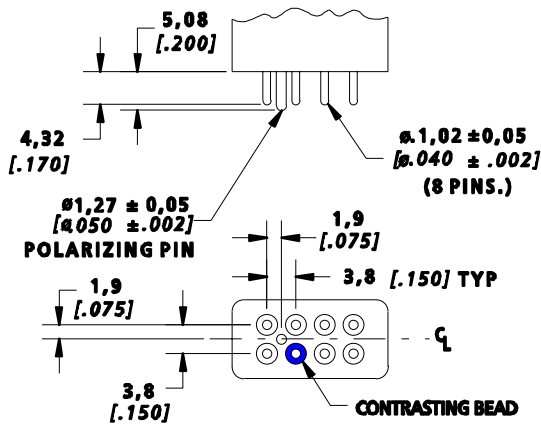

SOLDER PIN

STYLE A: TIN PLATED
STYLE B: SOLDER DIPPED

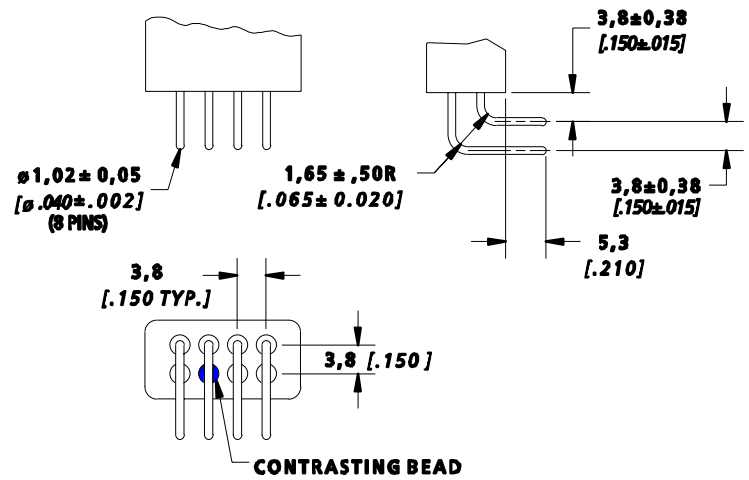

90° SOLDER PIN

STYLE D: TIN PLATED
STYLE E: SOLDER DIPPED

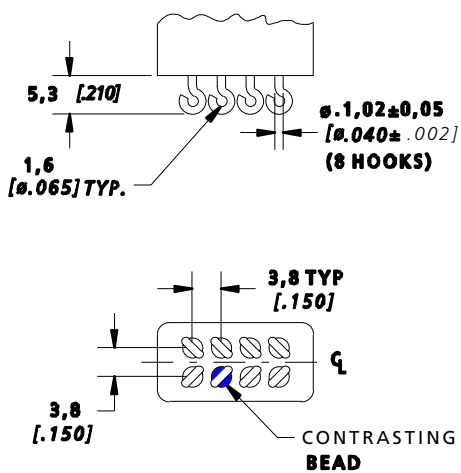

SOLDER HOOK

STYLE H: TIN PLATED
STYLE J: SOLDER DIPPED

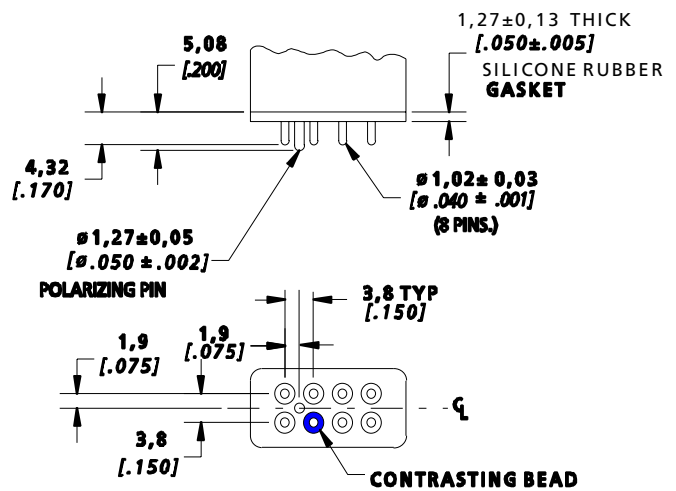

PLUG IN

STYLE M: GOLD PLATED WITH TIN
PLATED POLARIZING PIN

Coil characteristics

COIL CODE	DC							
	A	B	D	E	F	G	H	J
Nominal coil voltage	6	12	26,5	28	36	48	74	110
Max pull in voltage at 25° C	3,3	6,5	13,5	13,5	16,7	24	34,7	55
Max pull in voltage at 125° C	4,5	9,0	18	18	23	36	48	74
Min hold voltage at 125° C	2,3	4,5	7,0	7,0	10,0	12,0	21,0	32
Min drop out voltage at -70° C	0,25	0,5	1,2	1,5	2,0	2,4	4,0	5,5
Coil resistance (ohms ± 10% at 25° C)	18	72	350	400	650	1150	2740	6200
Max coil transient suppression (where applicable) VDC	42	42	42	42	100	100	100	154

OTHER VOLTAGES AVAILABLE FROM FACTORY ON REQUEST

Circuit diagram

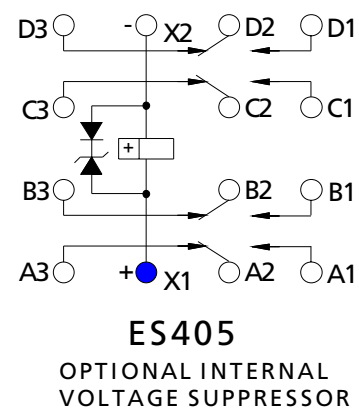
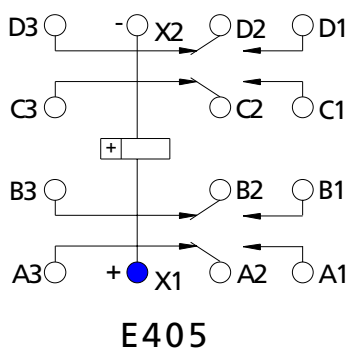

Mounting styles

DIMENSIONS ARE IN MM (IN.)
UNLESS OTHERWISE SPECIFIED, TOLERANCE IS $\pm 0,25$ [.010]

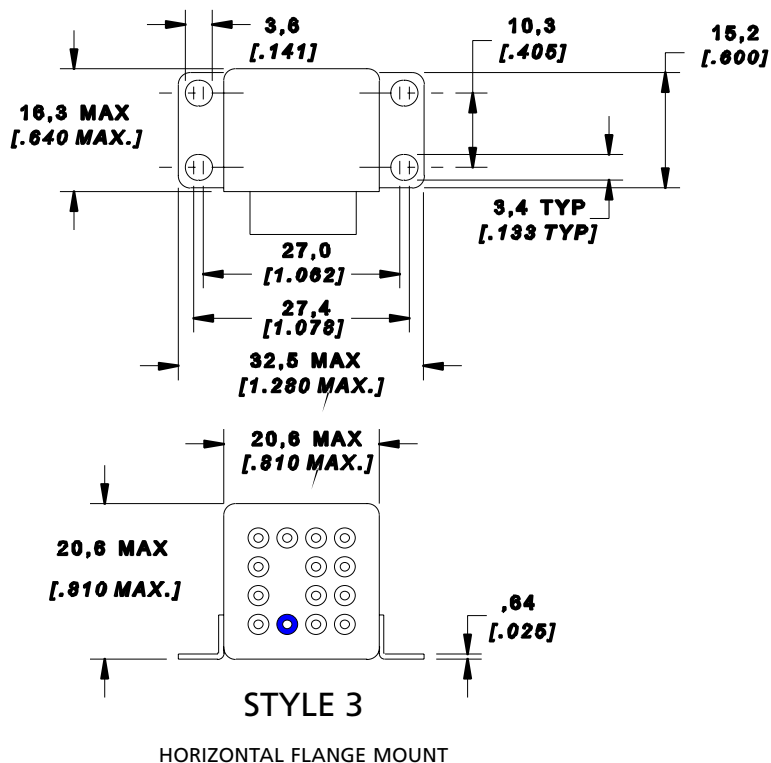
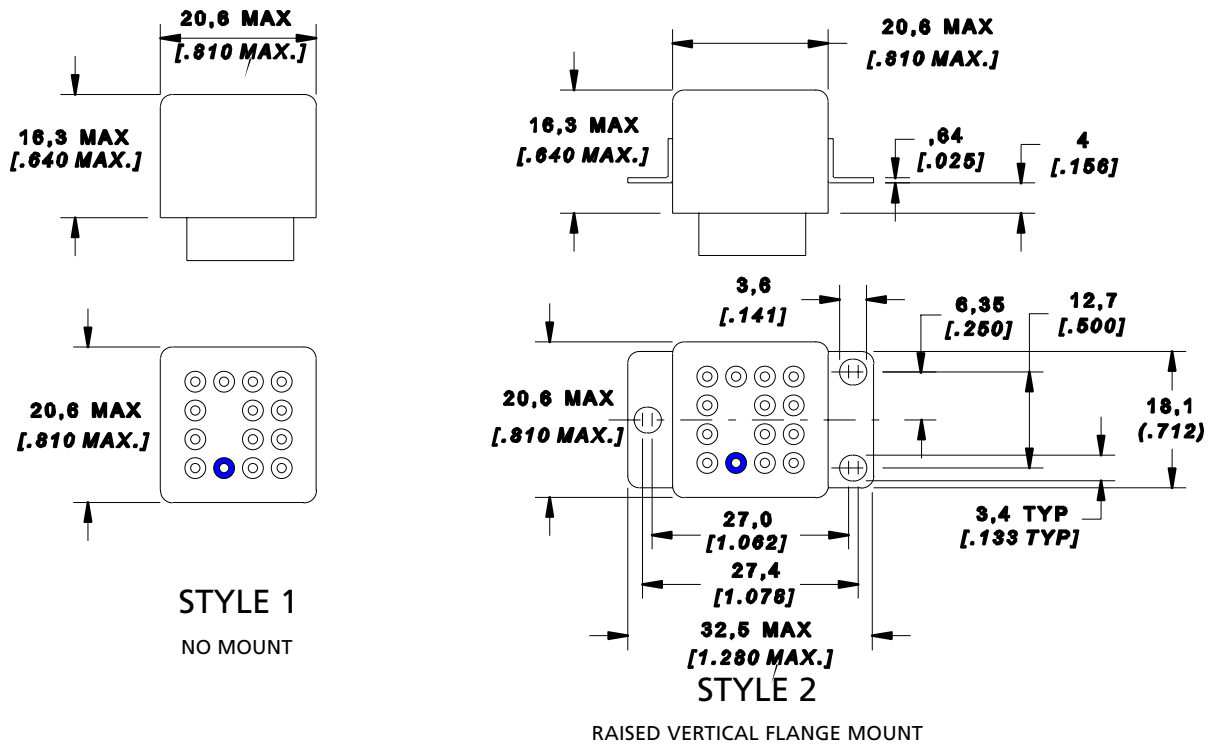

■ Mounting styles [cont.]

DIMENSIONS ARE IN MM (IN.)

UNLESS OTHERWISE SPECIFIED, TOLERANCE IS $\pm 0,25$ [.010]

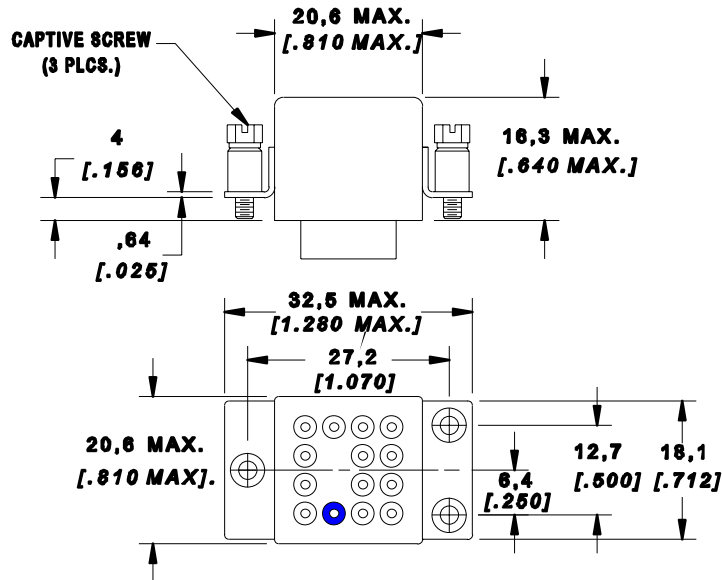

STYLE 8: M3 CAPTIVE SCREWS

STYLE C: #4-40 UNC CAPTIVE SCREWS

RAISED VERTICAL FLANGE MOUNT

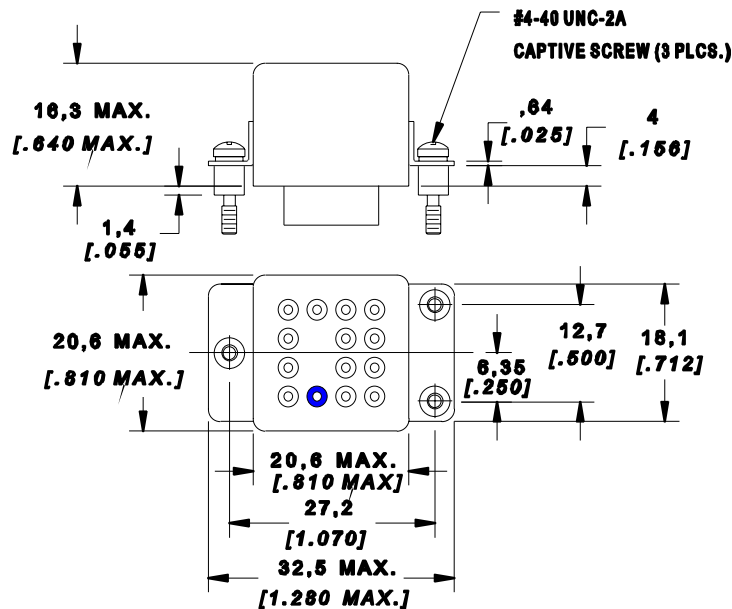

STYLE G

RAISED VERTICAL FLANGE MOUNT WITH CAPTIVE HARDWARE

■ Mounting Styles

DIMENSIONS ARE IN MM (IN.)
UNLESS OTHERWISE SPECIFIED, TOLERANCE IS $\pm 0,25$ [.010]

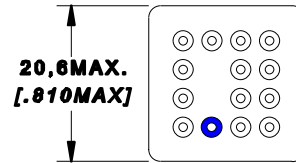
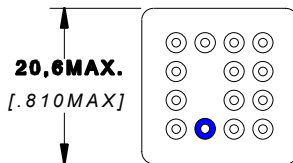
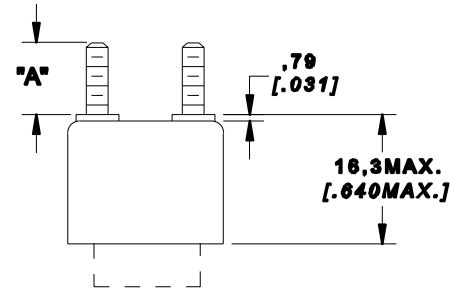
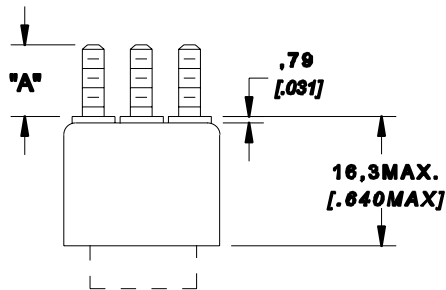
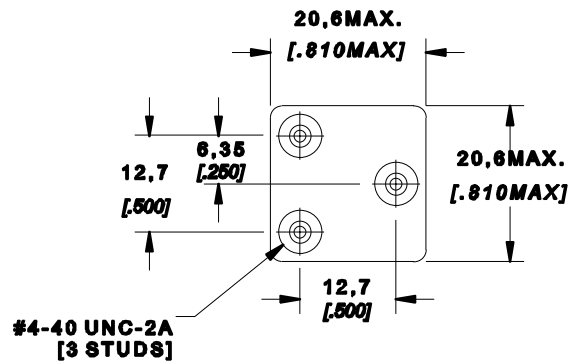
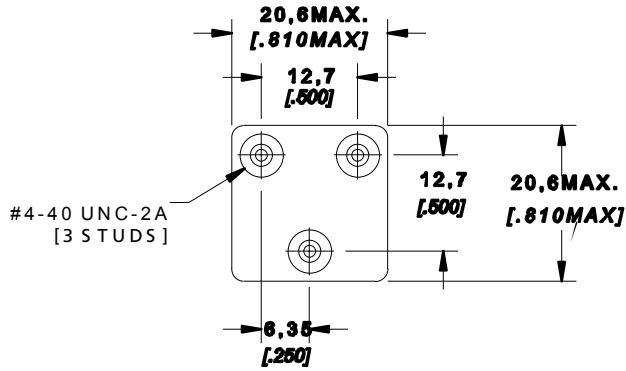

STYLE	DIM "A"
M	9,5 [.375]
R	6,35 [.250]

STYLE	DIM "A"
T	9,5 [.375]
U	6,35 [.250]

Termination Styles

DIMENSIONS ARE IN MM (IN.)
UNLESS OTHERWISE SPECIFIED, TOLERANCE IS $\pm 0,25$ [.010]

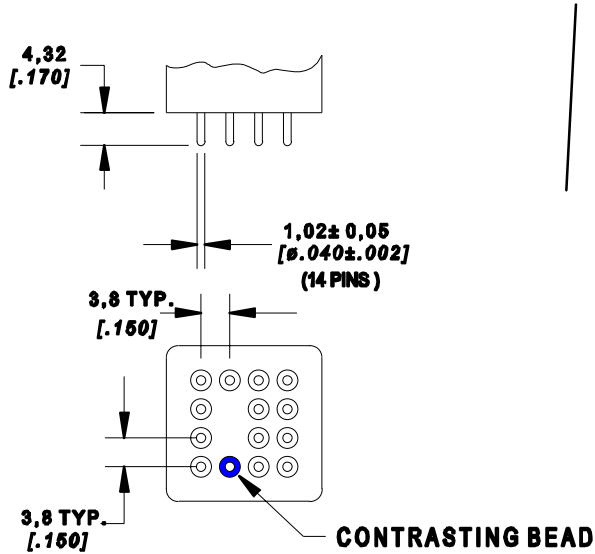

SOLDER PIN

STYLE A: TIN PLATED
STYLE B: SOLDER DIPPED

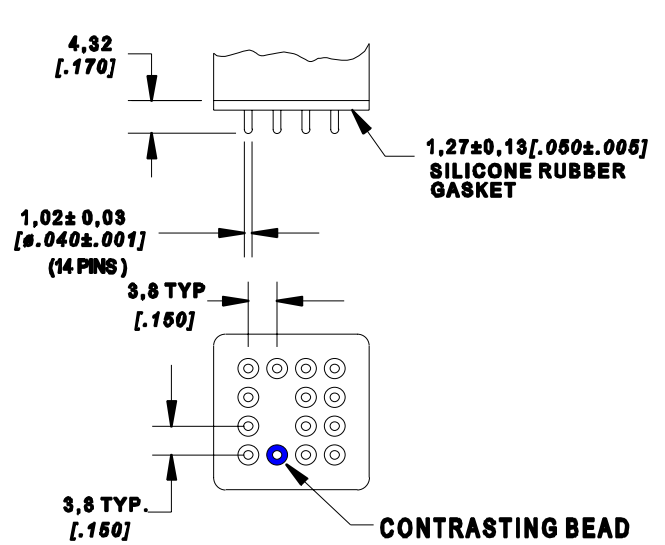

PLUG IN

STYLE M: GOLD PLATED

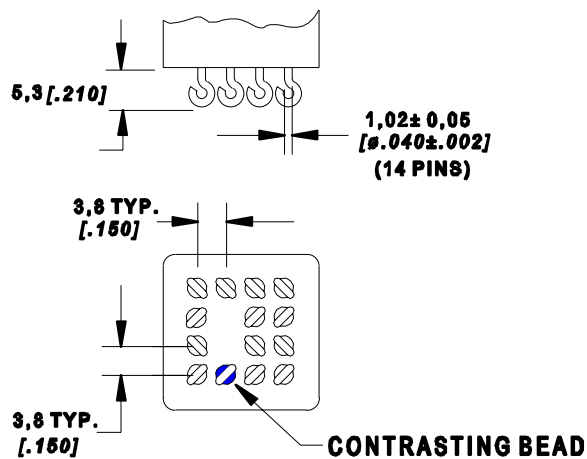

SOLDER HOOK

STYLE H: TIN PLATED
STYLE J: SOLDER DIPPED